

BLS7G2730L-200P; BLS7G2730LS-200P

LDMOS S-band radar power transistor

Rev. 3 — 12 July 2013

Product data sheet

1. Product profile

1.1 General description

200 W LDMOS power transistor for S-band radar applications in the frequency range from 2700 MHz to 3000 MHz.

Table 1. Typical performance
Typical RF performance at $T_{case} = 25\text{ °C}$.

Test signal	f (GHz)	V_{DS} (V)	P_L (W)	G_p (dB)	η_D (%)	t_r (ns)	t_f (ns)
Class-AB production test circuit							
pulsed RF [1]	2.7 to 3.0	32	200	12	48	8	5
Application circuit							
pulsed RF [2]	2.7 to 3.0	32	220	12.5	50	20	6
pulsed RF [3]	2.9 to 3.1	32	220	12.5	50	20	6

[1] $t_p = 300\text{ }\mu\text{s}$; $\delta = 10\%$; $I_{DQ} = 100\text{ mA}$

[2] $t_p = 3000\text{ }\mu\text{s}$; $\delta = 20\%$; $I_{DQ} = 50\text{ mA}$

[3] $t_p = 500\text{ }\mu\text{s}$; $\delta = 20\%$; $I_{DQ} = 50\text{ mA}$

1.2 Features and benefits

- High efficiency
- Excellent ruggedness
- Designed for broadband operation
- Excellent thermal stability
- Easy power control
- Integrated ESD protection
- High flexibility with respect to pulse formats
- Internally matched for ease of use
- Compliant to Directive 2002/95/EC, regarding Restriction of Hazardous Substances (RoHS)

1.3 Applications

- S-band radar applications in the frequency range 2700 MHz to 3000 MHz



2. Pinning information

Table 2. Pinning

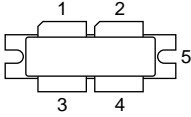
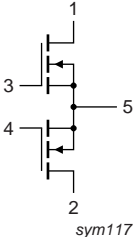
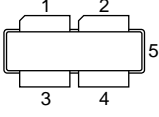
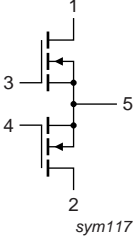
Pin	Description	Simplified outline	Graphic symbol
BLS7G2730L-200P (SOT539A)			
1	drain1		 sym117
2	drain2		
3	gate1		
4	gate2		
5	source		
BLS7G2730LS-200P (SOT539B)			
1	drain1		 sym117
2	drain2		
3	gate1		
4	gate2		
5	source		

[1] Connected to flange.

3. Ordering information

Table 3. Ordering information

Type number	Package		
	Name	Description	Version
BLS7G2730L-200P	-	flanged balanced ceramic package; 2 mounting holes; 4 leads	SOT539A
BLS7G2730LS-200P	-	earless flanged balanced ceramic package; 4 leads	SOT539B

4. Limiting values

Table 4. Limiting values

In accordance with the Absolute Maximum Rating System (IEC 60134).

Symbol	Parameter	Min	Max	Unit
V_{DS}	drain-source voltage	-	65	V
V_{GS}	gate-source voltage	-0.5	+13	V
T_{stg}	storage temperature	-65	+150	°C
T_j	junction temperature	[1]	225	°C

[1] Continuous use at maximum temperature will affect the reliability.

5. Thermal characteristics

Table 5. Thermal characteristics

Symbol	Parameter	Conditions	Typ	Unit
$Z_{th(j-c)}$	transient thermal impedance from junction to case	$T_{case} = 85\text{ °C}; P_L = 200\text{ W}$		
		$t_p = 300\text{ }\mu\text{s}; \delta = 10\text{ }\%$	0.13	K/W
		$t_p = 3000\text{ }\mu\text{s}; \delta = 20\text{ }\%$	0.19	K/W

6. Characteristics

Table 6. DC characteristics

$T_j = 25\text{ °C}$ unless otherwise specified.

Symbol	Parameter	Conditions	Min	Typ	Max	Unit
$V_{(BR)DSS}$	drain-source breakdown voltage	$V_{GS} = 0\text{ V}; I_D = 1.2\text{ mA}$	65	-	-	V
$V_{GS(th)}$	gate-source threshold voltage	$V_{DS} = 10\text{ V}; I_D = 120\text{ mA}$	1.5	1.9	2.3	V
I_{DSS}	drain leakage current	$V_{GS} = 0\text{ V}; V_{DS} = 28\text{ V}$	-	-	2.8	μA
I_{DSX}	drain cut-off current	$V_{GS} = V_{GS(th)} + 3.75\text{ V};$ $V_{DS} = 10\text{ V}$	-	22.5	-	A
I_{GSS}	gate leakage current	$V_{GS} = 11\text{ V}; V_{DS} = 0\text{ V}$	-	-	280	nA
g_{fs}	forward transconductance	$V_{DS} = 10\text{ V}; I_D = 0.12\text{ A}$	-	1	-	S
$R_{DS(on)}$	drain-source on-state resistance	$V_{GS} = V_{GS(th)} + 3.75\text{ V};$ $I_D = 4.2\text{ A}$	-	0.13	-	Ω

Table 7. RF characteristics

Test signal: pulsed RF; $t_p = 300\text{ }\mu\text{s}; \delta = 10\text{ }\%$; RF performance at $V_{DS} = 32\text{ V}; I_{Dq} = 100\text{ mA};$
 $T_{case} = 25\text{ °C};$ unless otherwise specified, in a class-AB production test circuit.

Symbol	Parameter	Conditions	Min	Typ	Max	Unit
G_p	power gain	$P_L = 200\text{ W}$	9.8	12	-	dB
RL_{in}	input return loss	$P_L = 200\text{ W}$	-	-10	-6	dB
η_D	drain efficiency	$P_L = 200\text{ W}$	43	48	-	%
$P_{droop(pulse)}$	pulse droop power	$P_L = 200\text{ W}$	-	0	0.25	dB
t_r	rise time	$P_L = 200\text{ W}$	-	8	50	ns
t_f	fall time	$P_L = 200\text{ W}$	-	5	50	ns

7. Test information

7.1 Ruggedness in class-AB operation

The BLS7G2730L-200P and BLS7G2730LS-200P are capable of withstanding a load mismatch corresponding to $VSWR = 10 : 1$ through all phases under following conditions: $V_{DS} = 32\text{ V}; I_{Dq} = 100\text{ mA}; P_L = 200\text{ W}; f = 2700\text{ MHz}; t_p = 300\text{ }\mu\text{s}; \delta = 10\text{ }\%$

7.2 Impedance information

Table 8. Typical impedance

Measured load-pull data half device; $V_{DS} = 32\text{ V}$; $I_{Dq} = 100\text{ mA}$.

f (MHz)	Z_S [1] (Ω)	Z_L [1] (Ω)
2700	2.0 – j5.8	3.7 – j6.4
2800	1.6 – j5.9	3.8 – j6.9
2900	2.6 – j6.2	3.8 – j6.9
3000	3.4 – j6.0	3.7 – j6.4

[1] Z_S and Z_L defined in [Figure 1](#).

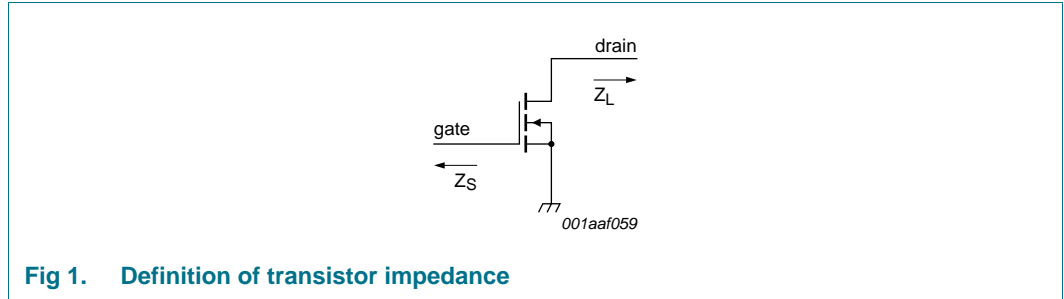

7.3 Production test circuit

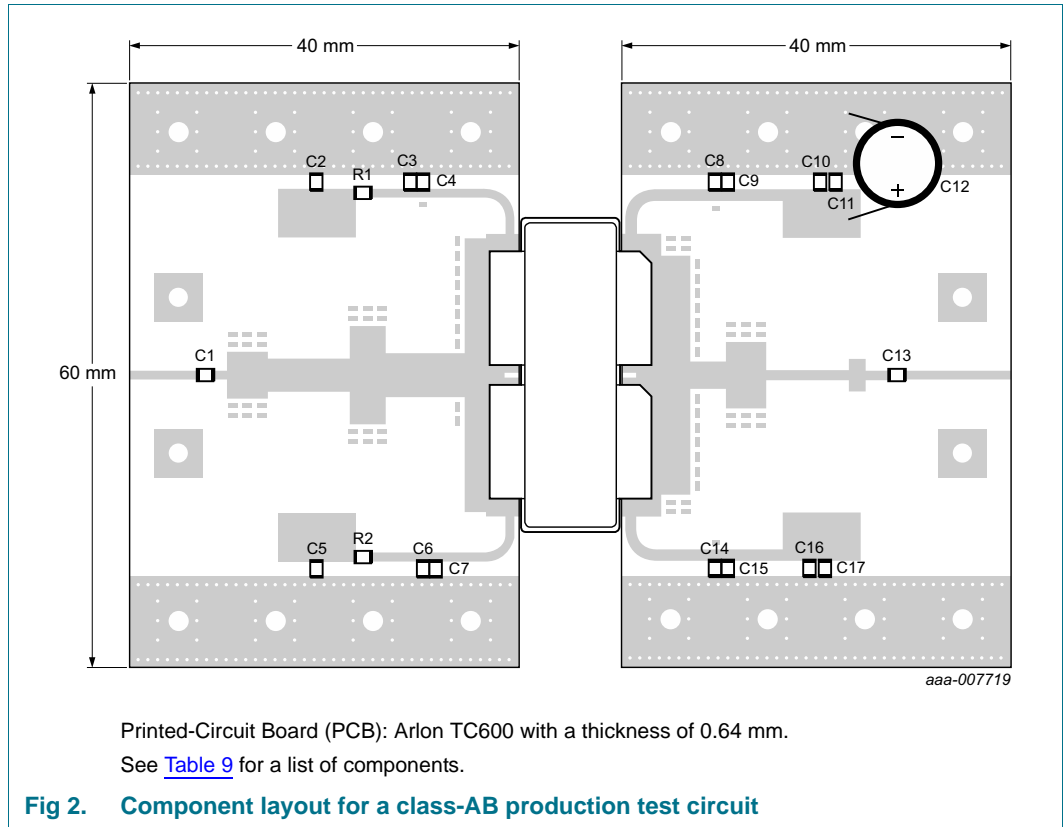

Table 9. List of components test circuit

See [Figure 2](#).

Component	Description	Value	Remarks
C1, C3, C6, C9, C13, C15	multilayer ceramic chip capacitor	18 pF	[1] ATC600F
C2, C5, C10, C16	multilayer ceramic chip capacitor	1 μF	[2]
C4, C7, C8, C14	multilayer ceramic chip capacitor	12 pF	[1] ATC600F
C11, C17	multilayer ceramic chip capacitor	10 μF	[2]
C12	electrolytic capacitor	2200 μF, 63 V	
R1, R2	chip resistor	9.1 Ω	[3]

[1] American Technical Ceramics type 600F or capacitor of same quality.

[2] Murata or capacitor of same quality.

[3] Vishay Dale or capacitor of same quality.

7.4 Application circuit

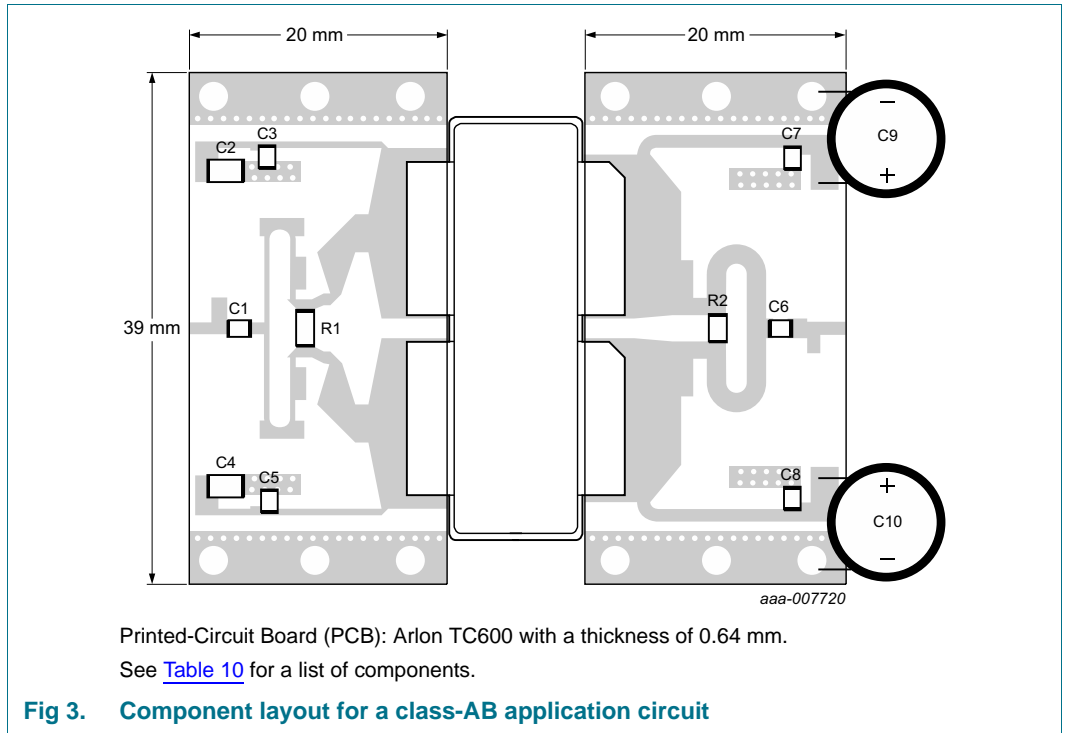

Table 10. List of components application circuit

See [Figure 2](#).

Component	Description	Value	Remarks
C1, C3, C5, C6, C7, C8	multilayer ceramic chip capacitor	12 pF	[1] ATC600F
C2, C4	multilayer ceramic chip capacitor	1 μF	[2]
C9, C10	electrolytic capacitor	2200 μF, 50 V	
R1, R2	chip resistor	50 Ω	[3]

[1] American Technical Ceramics type 600F or capacitor of same quality.

[2] Murata or capacitor of same quality.

[3] Vishay Dale or capacitor of same quality.

7.5 Graphical data

7.5.1 Test circuit

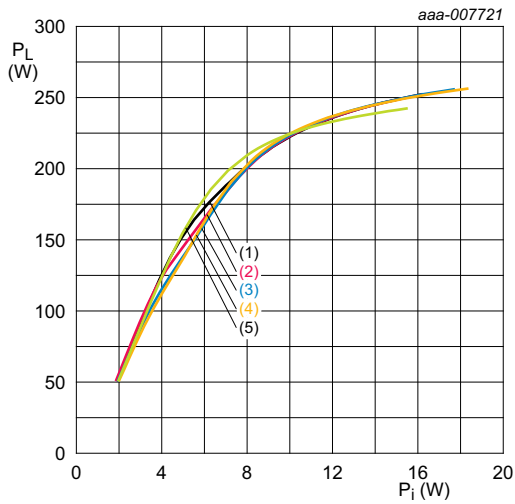

- $V_{DS} = 32\text{ V}; I_{Dq} = 100\text{ mA}; t_p = 300\text{ }\mu\text{s}; \delta = 10\text{ }\%$.
- (1) $f = 2700\text{ MHz}$
 - (2) $f = 2800\text{ MHz}$
 - (3) $f = 2850\text{ MHz}$
 - (4) $f = 2900\text{ MHz}$
 - (5) $f = 3000\text{ MHz}$

Fig 4. Output power as a function of input power; typical values

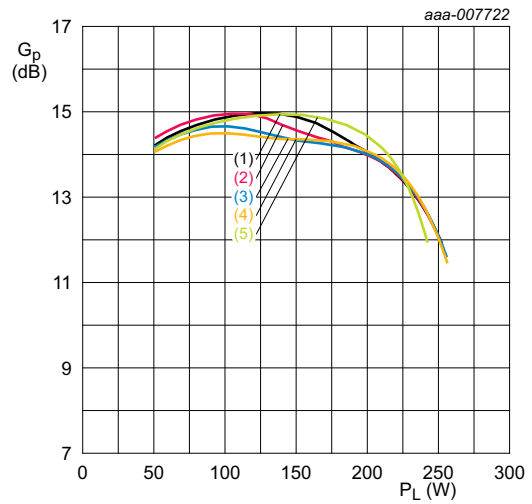

- $V_{DS} = 32\text{ V}; I_{Dq} = 100\text{ mA}; t_p = 300\text{ }\mu\text{s}; \delta = 10\text{ }\%$.
- (1) $f = 2700\text{ MHz}$
 - (2) $f = 2800\text{ MHz}$
 - (3) $f = 2850\text{ MHz}$
 - (4) $f = 2900\text{ MHz}$
 - (5) $f = 3000\text{ MHz}$

Fig 5. Power gain as a function of output power; typical values

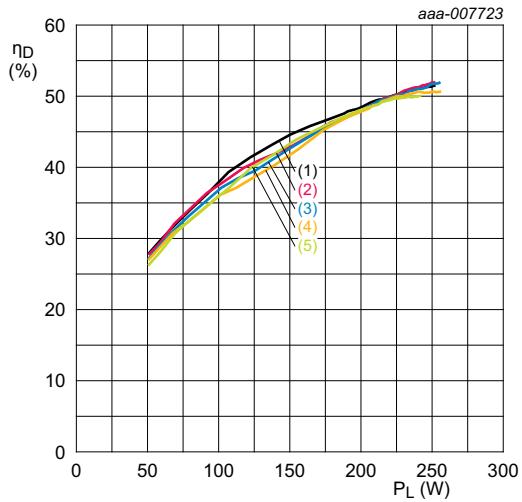

$V_{DS} = 32\text{ V}$; $I_{DQ} = 100\text{ mA}$; $t_p = 300\text{ }\mu\text{s}$; $\delta = 10\text{ }\%$.

- (1) $f = 2700\text{ MHz}$
- (2) $f = 2800\text{ MHz}$
- (3) $f = 2850\text{ MHz}$
- (4) $f = 2900\text{ MHz}$
- (5) $f = 3000\text{ MHz}$

Fig 6. Drain efficiency as a function of output power; typical values

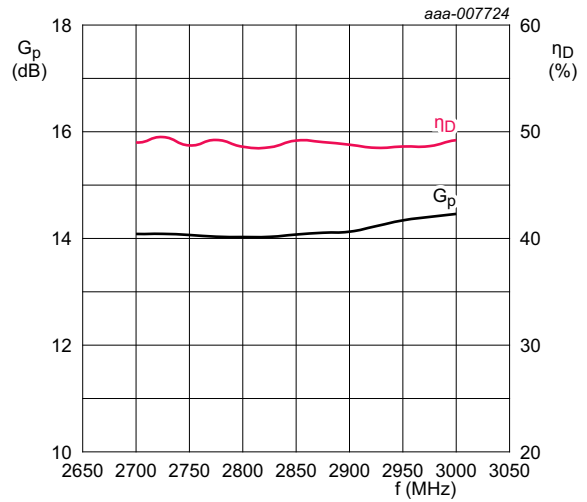

$V_{DS} = 32\text{ V}$; $P_L = 200\text{ W}$; $I_{DQ} = 100\text{ mA}$; $t_p = 300\text{ }\mu\text{s}$; $\delta = 10\text{ }\%$.

Fig 7. Power gain and drain efficiency as function of frequency; typical values

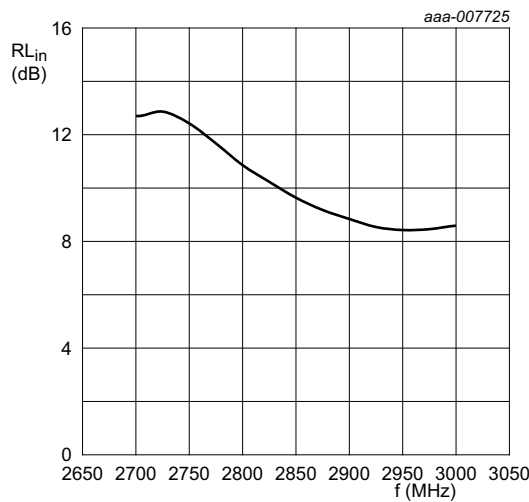

$V_{DS} = 32\text{ V}$; $P_L = 200\text{ W}$; $I_{DQ} = 100\text{ mA}$; $t_p = 300\text{ }\mu\text{s}$; $\delta = 10\text{ }\%$.

Fig 8. Input return loss as a function of frequency; typical values

7.5.2 Application circuit

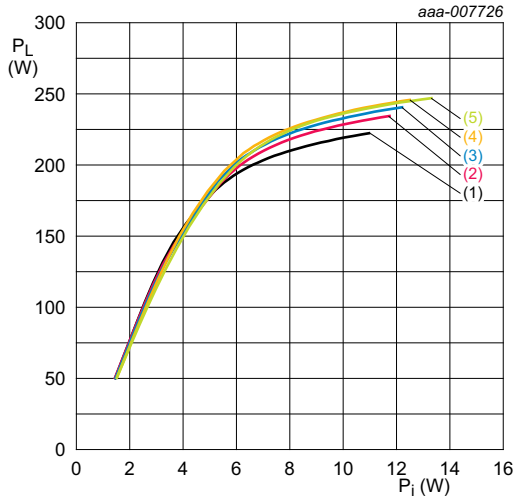

- $V_{DS} = 32\text{ V}; I_{Dq} = 50\text{ mA}; t_p = 3000\ \mu\text{s}; \delta = 20\ \%$.
- (1) $f = 2700\text{ MHz}$
 - (2) $f = 2800\text{ MHz}$
 - (3) $f = 2850\text{ MHz}$
 - (4) $f = 2900\text{ MHz}$
 - (5) $f = 3000\text{ MHz}$

Fig 9. Output power as a function of input power; typical values

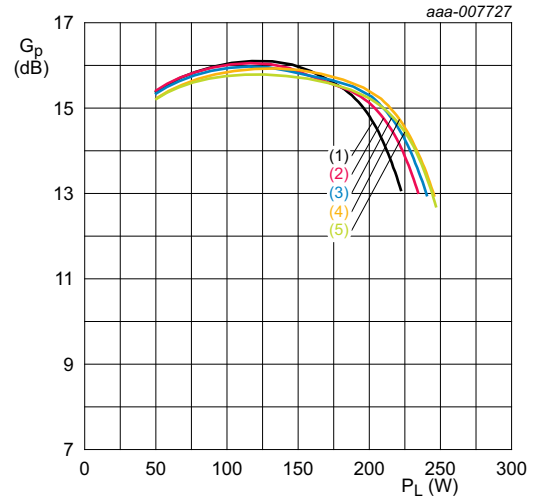

- $V_{DS} = 32\text{ V}; I_{Dq} = 50\text{ mA}; t_p = 3000\ \mu\text{s}; \delta = 20\ \%$.
- (1) $f = 2700\text{ MHz}$
 - (2) $f = 2800\text{ MHz}$
 - (3) $f = 2850\text{ MHz}$
 - (4) $f = 2900\text{ MHz}$
 - (5) $f = 3000\text{ MHz}$

Fig 10. Power gain as a function of output power; typical values

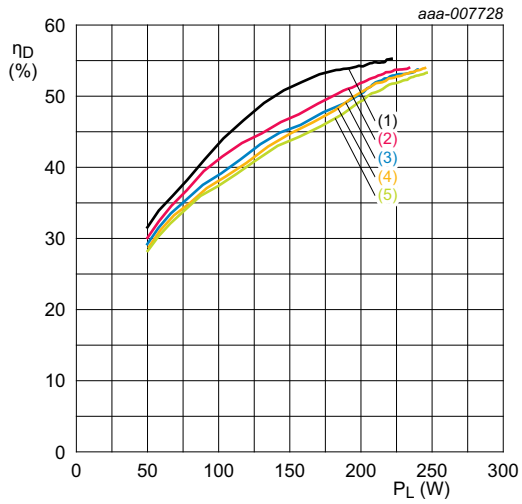

$V_{DS} = 32\text{ V}$; $I_{Dq} = 50\text{ mA}$; $t_p = 3000\text{ }\mu\text{s}$; $\delta = 20\text{ }\%$.

- (1) $f = 2700\text{ MHz}$
- (2) $f = 2800\text{ MHz}$
- (3) $f = 2850\text{ MHz}$
- (4) $f = 2900\text{ MHz}$
- (5) $f = 3000\text{ MHz}$

Fig 11. Drain efficiency as a function of output power; typical values

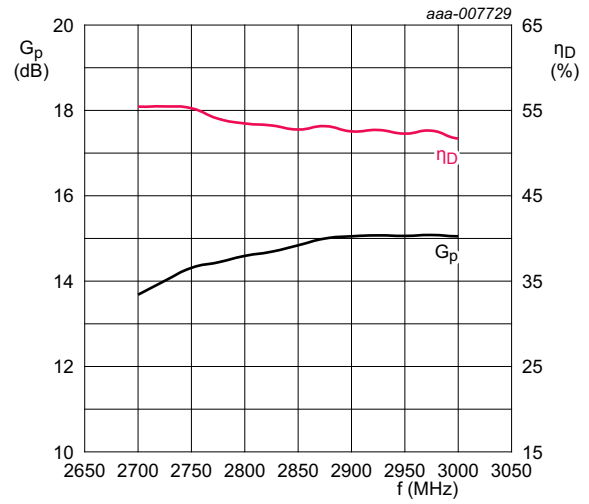

$V_{DS} = 32\text{ V}$; $P_L = 220\text{ W}$; $I_{Dq} = 50\text{ mA}$; $t_p = 3000\text{ }\mu\text{s}$; $\delta = 20\text{ }\%$.

Fig 12. Power gain and drain efficiency as function of frequency; typical values

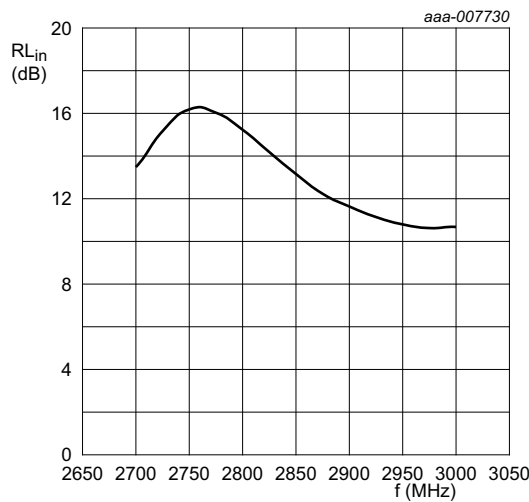

$V_{DS} = 32\text{ V}$; $P_L = 220\text{ W}$; $I_{Dq} = 50\text{ mA}$; $t_p = 3000\text{ }\mu\text{s}$; $\delta = 20\text{ }\%$.

Fig 13. Input return loss as a function of frequency; typical values

8. Package outline

Flanged balanced ceramic package; 2 mounting holes; 4 leads

SOT539A

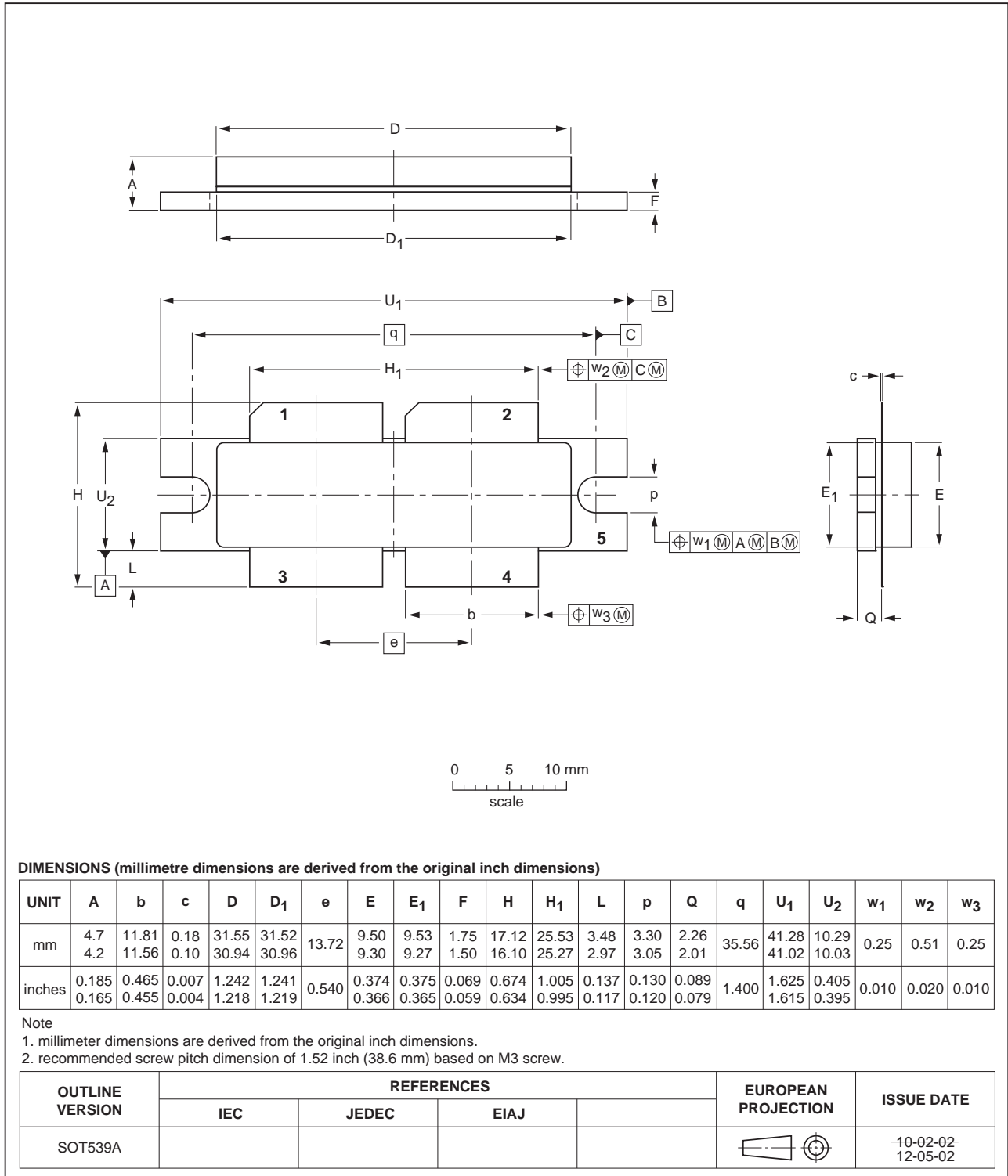

Fig 14. Package outline SOT539A

Earless flanged balanced ceramic package; 4 leads

SOT539B

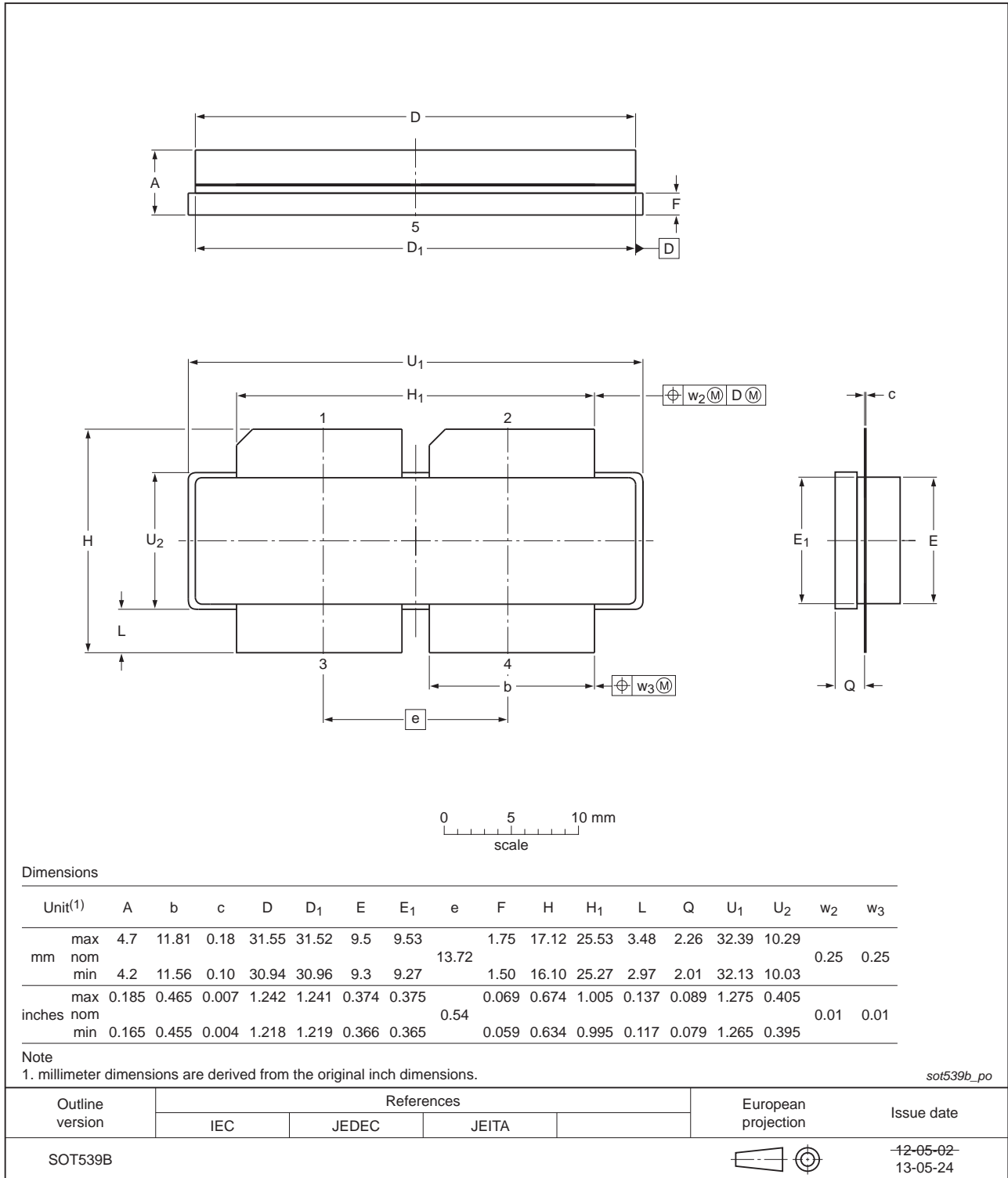

Fig 15. Package outline SOT539B

9. Handling information

CAUTION



This device is sensitive to ElectroStatic Discharge (ESD). Observe precautions for handling electrostatic sensitive devices.

Such precautions are described in the *ANSI/ESD S20.20*, *IEC/ST 61340-5*, *JESD625-A* or equivalent standards.

10. Abbreviations

Table 11. Abbreviations

Acronym	Description
ESD	ElectroStatic Discharge
LDMOS	Laterally Diffused Metal-Oxide Semiconductor
S-band	Short wave band
VSWR	Voltage Standing-Wave Ratio

11. Revision history

Table 12. Revision history

Document ID	Release date	Data sheet status	Change notice	Supersedes
BLS7G2730S-200P_LS-200P v.3	20130712	Product data sheet	-	BLS7G2730S-200P_LS-200P v.2
Modifications:	<ul style="list-style-type: none"> The package outline Figure 15 is updated. 			
BLS7G2730S-200P_LS-200P v.2	20130603	Product data sheet	-	BLS7G2730S-200P_LS-200P v.1
Modifications	<ul style="list-style-type: none"> Table 1 on page 1: table has been updated Section 1.2 on page 1: section has been updated Table 4 on page 2: table has been updated Table 5 on page 3: table has been updated Table 6 on page 3: table has been updated Table 7 on page 3: table has been updated Section 7 on page 3: section has been added Figure 15 on page 11: figure has been updated 			
BLS7G2730S-200P_LS-200P v.1	20130129	Objective data sheet	-	-

12. Legal information

12.1 Data sheet status

Document status ^{[1][2]}	Product status ^[3]	Definition
Objective [short] data sheet	Development	This document contains data from the objective specification for product development.
Preliminary [short] data sheet	Qualification	This document contains data from the preliminary specification.
Product [short] data sheet	Production	This document contains the product specification.

[1] Please consult the most recently issued document before initiating or completing a design.

[2] The term 'short data sheet' is explained in section "Definitions".

[3] The product status of device(s) described in this document may have changed since this document was published and may differ in case of multiple devices. The latest product status information is available on the Internet at URL <http://www.nxp.com>.

12.2 Definitions

Draft — The document is a draft version only. The content is still under internal review and subject to formal approval, which may result in modifications or additions. NXP Semiconductors does not give any representations or warranties as to the accuracy or completeness of information included herein and shall have no liability for the consequences of use of such information.

Short data sheet — A short data sheet is an extract from a full data sheet with the same product type number(s) and title. A short data sheet is intended for quick reference only and should not be relied upon to contain detailed and full information. For detailed and full information see the relevant full data sheet, which is available on request via the local NXP Semiconductors sales office. In case of any inconsistency or conflict with the short data sheet, the full data sheet shall prevail.

Product specification — The information and data provided in a Product data sheet shall define the specification of the product as agreed between NXP Semiconductors and its customer, unless NXP Semiconductors and customer have explicitly agreed otherwise in writing. In no event however, shall an agreement be valid in which the NXP Semiconductors product is deemed to offer functions and qualities beyond those described in the Product data sheet.

12.3 Disclaimers

Limited warranty and liability — Information in this document is believed to be accurate and reliable. However, NXP Semiconductors does not give any representations or warranties, expressed or implied, as to the accuracy or completeness of such information and shall have no liability for the consequences of use of such information. NXP Semiconductors takes no responsibility for the content in this document if provided by an information source outside of NXP Semiconductors.

In no event shall NXP Semiconductors be liable for any indirect, incidental, punitive, special or consequential damages (including - without limitation - lost profits, lost savings, business interruption, costs related to the removal or replacement of any products or rework charges) whether or not such damages are based on tort (including negligence), warranty, breach of contract or any other legal theory.

Notwithstanding any damages that customer might incur for any reason whatsoever, NXP Semiconductors' aggregate and cumulative liability towards customer for the products described herein shall be limited in accordance with the *Terms and conditions of commercial sale* of NXP Semiconductors.

Right to make changes — NXP Semiconductors reserves the right to make changes to information published in this document, including without limitation specifications and product descriptions, at any time and without notice. This document supersedes and replaces all information supplied prior to the publication hereof.

Suitability for use — NXP Semiconductors products are not designed, authorized or warranted to be suitable for use in life support, life-critical or safety-critical systems or equipment, nor in applications where failure or malfunction of an NXP Semiconductors product can reasonably be expected to result in personal injury, death or severe property or environmental damage. NXP Semiconductors and its suppliers accept no liability for inclusion and/or use of NXP Semiconductors products in such equipment or applications and therefore such inclusion and/or use is at the customer's own risk.

Applications — Applications that are described herein for any of these products are for illustrative purposes only. NXP Semiconductors makes no representation or warranty that such applications will be suitable for the specified use without further testing or modification.

Customers are responsible for the design and operation of their applications and products using NXP Semiconductors products, and NXP Semiconductors accepts no liability for any assistance with applications or customer product design. It is customer's sole responsibility to determine whether the NXP Semiconductors product is suitable and fit for the customer's applications and products planned, as well as for the planned application and use of customer's third party customer(s). Customers should provide appropriate design and operating safeguards to minimize the risks associated with their applications and products.

NXP Semiconductors does not accept any liability related to any default, damage, costs or problem which is based on any weakness or default in the customer's applications or products, or the application or use by customer's third party customer(s). Customer is responsible for doing all necessary testing for the customer's applications and products using NXP Semiconductors products in order to avoid a default of the applications and the products or of the application or use by customer's third party customer(s). NXP does not accept any liability in this respect.

Limiting values — Stress above one or more limiting values (as defined in the Absolute Maximum Ratings System of IEC 60134) will cause permanent damage to the device. Limiting values are stress ratings only and (proper) operation of the device at these or any other conditions above those given in the Recommended operating conditions section (if present) or the Characteristics sections of this document is not warranted. Constant or repeated exposure to limiting values will permanently and irreversibly affect the quality and reliability of the device.

Terms and conditions of commercial sale — NXP Semiconductors products are sold subject to the general terms and conditions of commercial sale, as published at <http://www.nxp.com/profile/terms>, unless otherwise agreed in a valid written individual agreement. In case an individual agreement is concluded only the terms and conditions of the respective agreement shall apply. NXP Semiconductors hereby expressly objects to applying the customer's general terms and conditions with regard to the purchase of NXP Semiconductors products by customer.

No offer to sell or license — Nothing in this document may be interpreted or construed as an offer to sell products that is open for acceptance or the grant, conveyance or implication of any license under any copyrights, patents or other industrial or intellectual property rights.

Export control — This document as well as the item(s) described herein may be subject to export control regulations. Export might require a prior authorization from competent authorities.

Non-automotive qualified products — Unless this data sheet expressly states that this specific NXP Semiconductors product is automotive qualified, the product is not suitable for automotive use. It is neither qualified nor tested in accordance with automotive testing or application requirements. NXP Semiconductors accepts no liability for inclusion and/or use of non-automotive qualified products in automotive equipment or applications.

In the event that customer uses the product for design-in and use in automotive applications to automotive specifications and standards, customer (a) shall use the product without NXP Semiconductors' warranty of the product for such automotive applications, use and specifications, and (b) whenever customer uses the product for automotive applications beyond

NXP Semiconductors' specifications such use shall be solely at customer's own risk, and (c) customer fully indemnifies NXP Semiconductors for any liability, damages or failed product claims resulting from customer design and use of the product for automotive applications beyond NXP Semiconductors' standard warranty and NXP Semiconductors' product specifications.

Translations — A non-English (translated) version of a document is for reference only. The English version shall prevail in case of any discrepancy between the translated and English versions.

12.4 Trademarks

Notice: All referenced brands, product names, service names and trademarks are the property of their respective owners.

13. Contact information

For more information, please visit: <http://www.nxp.com>

For sales office addresses, please send an email to: salesaddresses@nxp.com

14. Contents

1 Product profile 1

1.1 General description 1

1.2 Features and benefits 1

1.3 Applications 1

2 Pinning information 2

3 Ordering information 2

4 Limiting values 2

5 Thermal characteristics 3

6 Characteristics 3

7 Test information 3

7.1 Ruggedness in class-AB operation 3

7.2 Impedance information 4

7.3 Production test circuit 4

7.4 Application circuit 5

7.5 Graphical data 6

7.5.1 Test circuit 6

7.5.2 Application circuit 8

8 Package outline 10

9 Handling information 12

10 Abbreviations 12

11 Revision history 12

12 Legal information 13

12.1 Data sheet status 13

12.2 Definitions 13

12.3 Disclaimers 13

12.4 Trademarks 14

13 Contact information 14

14 Contents 15

Please be aware that important notices concerning this document and the product(s) described herein, have been included in section 'Legal information'.

© NXP B.V. 2013. All rights reserved.

For more information, please visit: <http://www.nxp.com>
 For sales office addresses, please send an email to: salesaddresses@nxp.com

Date of release: 12 July 2013
 Document identifier: BLS7G2730L-200P_LS-200P